

Silicon Carbide Schottky Diode

V_{RRM}	650V
I_F (135°C)	56A
Q_C	135nC

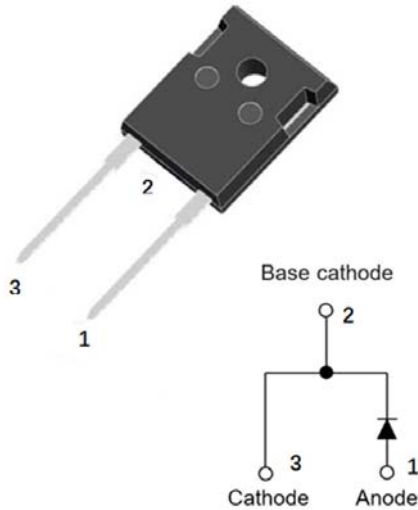

Features

- Positive temperature coefficient
- Temperature-independent switching
- Maximum working temperature at 175 °C
- Unipolar devices and zero reverse recovery current
- Zero forward recovery voltage
- Essentially no switching losses
- Reduction of heat sink requirements
- High-frequency operation
- Reduction of EMI

Typical Applications

Typical applications are in power factor correction(PFC), solar inverter, uninterruptible power supply, motor drives, photovoltaic inverter, electric car and charger.

Mechanical Data

- **Package:** TO-247AC
Molding compound meets UL 94 V-0 flammability rating, RoHS-compliant, halogen-free
- **Terminals:** Tin plated leads
- **Polarity:** As marked

■Maximum Ratings ($T_C=25^\circ\text{C}$ Unless otherwise specified)

PARAMETER	SYMBOL	UNIT	VALUE
Device marking code			D106550NQG3
Reverse voltage (repetitive peak) @ $T_j=25^\circ\text{C}$	V_{RRM}	V	650
Reverse voltage (Surge Peak) @ $T_j=25^\circ\text{C}$	V_{RSM}	V	650
Reverse voltage (DC) @ $T_j=25^\circ\text{C}$	V_{DC}	V	650
Continuous forward current @ $T_c=25^\circ\text{C}$			119
Continuous forward current @ $T_c=135^\circ\text{C}$	I_F	A	56
Continuous forward current @ $T_c=143^\circ\text{C}$			50
Non-repetitive peak forward surge current @ $T_c=25^\circ\text{C}$, $t_p=10\text{ms}$, Half Sine Wave	I_{FSM}	A	380
Power Dissipation@ $T_c=25^\circ\text{C}$			454
Power Dissipation@ $T_c=110^\circ\text{C}$	P_{TOT}	W	196
i^2t Value@ $T_c=25^\circ\text{C}$, $t_p=10\text{ms}$	$\int i^2 dt$	A^2S	722
Operating junction and Storage temperature range	T_j, T_{stg}	$^\circ\text{C}$	-55 to +175



YJD106550NQG3

■Electrical Characteristics (Per Leg)

PARAMETER	SYMBOL	UNIT	TEST CONDITIONS	Typ.	Max.
Forward voltage drop	V_F	V	$I_F=50A, T_J=25^{\circ}C$	1.45	1.6
			$I_F=50A, T_J=175^{\circ}C$	1.9	-
Reverse leakage current	I_R	μA	$V_R=650V, T_J=25^{\circ}C$	3	25
			$V_R=650V, T_J=175^{\circ}C$	20	-
Total capacitive charge	Q_C	nC	$V_R=400V, T_J=25^{\circ}C, Q_C=\int_0^{V_R} I_R(V)dV$	135.3	-
Total capacitance	C	pF	$V_R=0V, f=1MHZ$	2453	-
			$V_R=200V, f=1MHZ$	247	-
			$V_R=400V, f=1MHZ$	243	-
Capacitance Stored Energy	E_C	μJ	$V_R=400V$	16.5	-

■Thermal Characteristics ($T_a=25^{\circ}C$ Unless otherwise specified)

PARAMETER	SYMBOL	UNIT	Value
Thermal resistance	$R_{\theta J-C}$	$^{\circ}C/W$	0.33

■Typical Characteristics

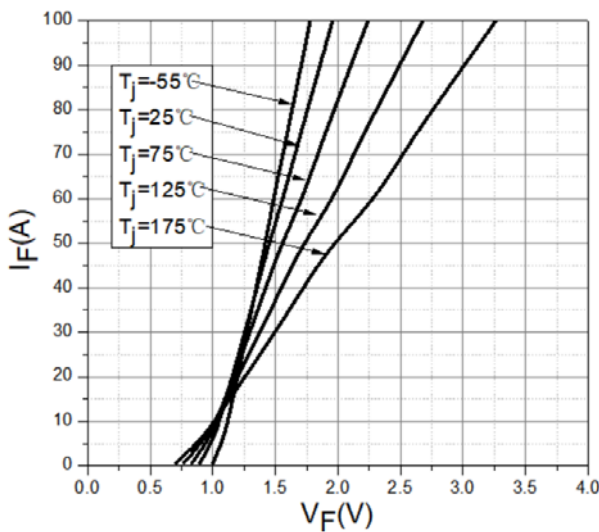

Figure 1. Forward Characteristics

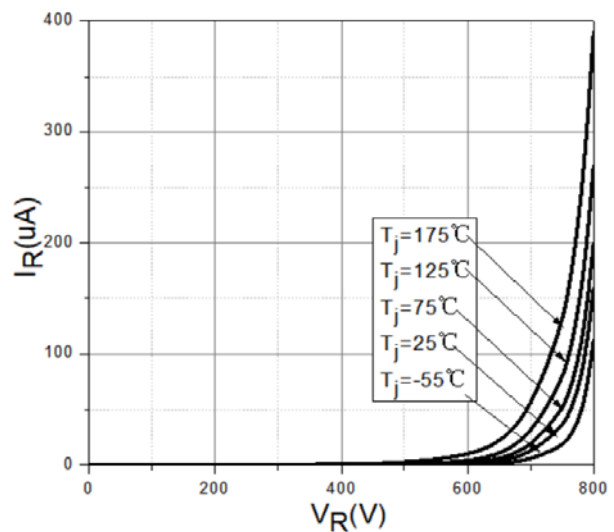

Figure2. Reverse Characteristic



YJD106550NQG3

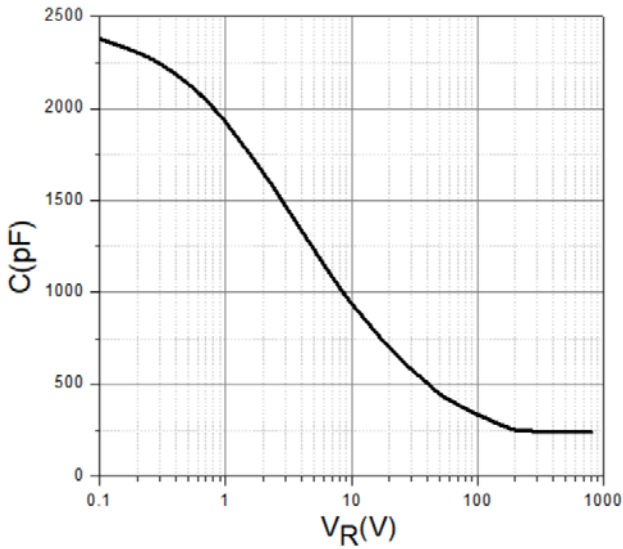

Figure 3. Capacitance vs. Reverse Voltage

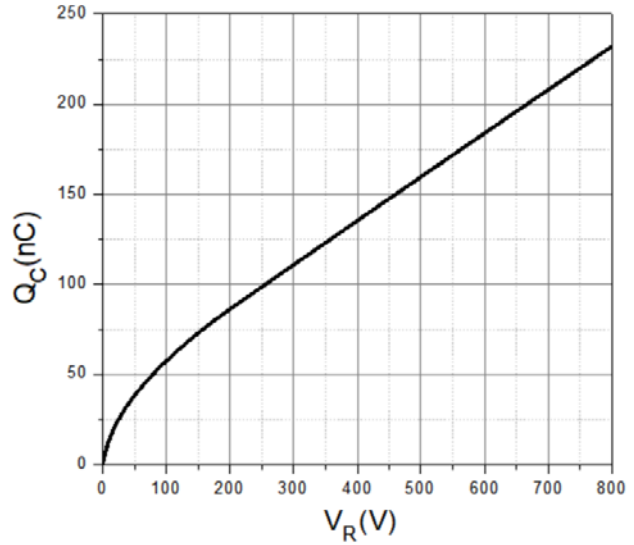

Figure 4. Total Capacitance Charge vs. Reverse Voltage

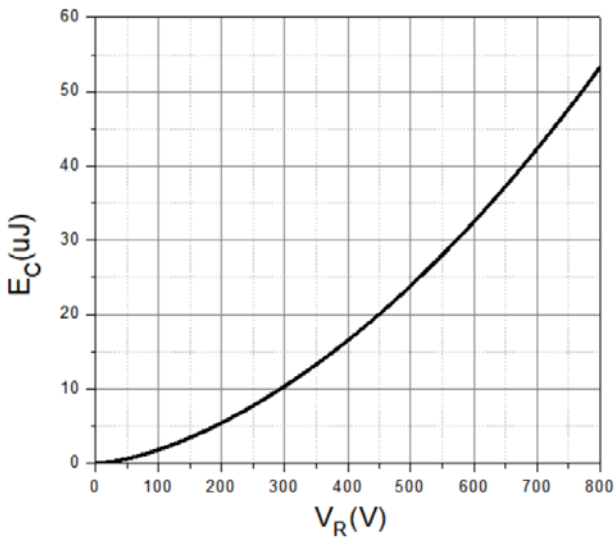

Figure 5. Capacitance Stored Energy

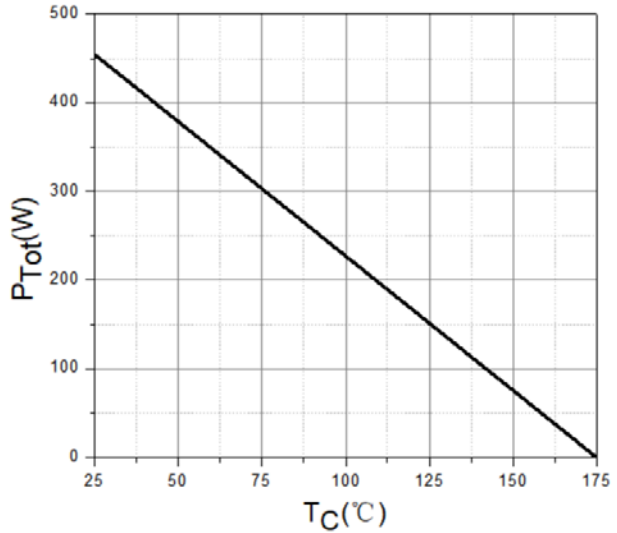

Figure 6. Power Derating

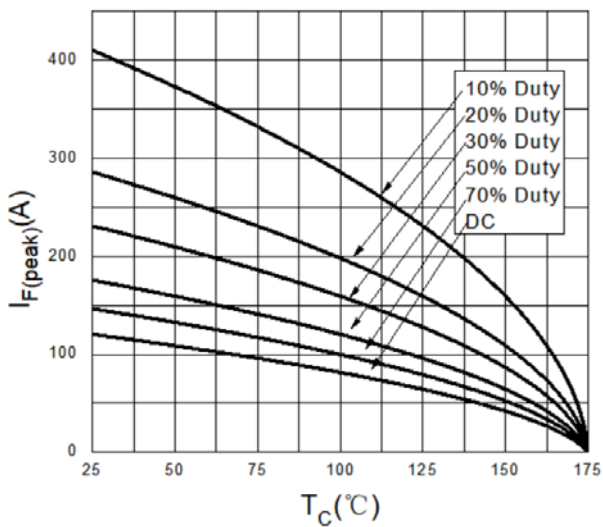

Figure 7. Current Derating

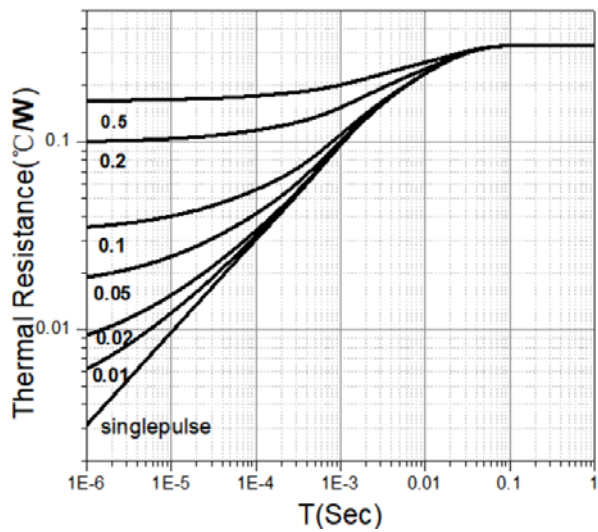

Figure 8. Transient Thermal Impedance



YJD106550NQG3

■Outline Dimensions

TO-247AC

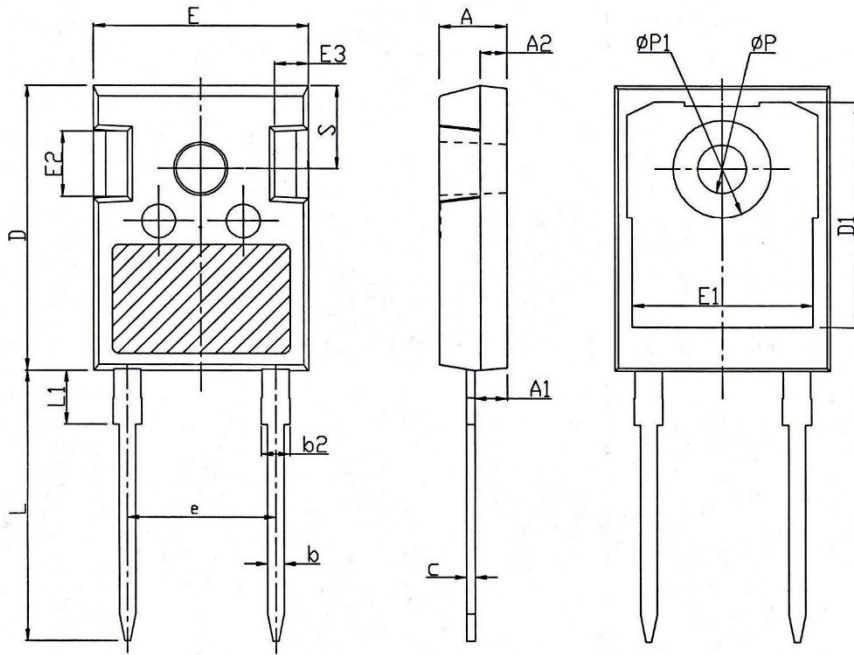

TO-247AC		
Dim	Min	Max
A	4.80	5.20
A1	2.21	2.61
A2	1.85	2.15
b	1.11	1.36
b2	1.91	2.21
c	0.51	0.75
D	20.70	21.30
D1	16.25	16.85
E	15.50	16.10
E1	13.00	13.60
E2	4.80	5.20
E3	2.30	2.70
e	10.88BSC	
L	19.62	20.22
L1	-	4.30
ϕP	3.40	3.80
$\phi P1$	-	7.30
S	6.15BSC	



Disclaimer

The information presented in this document is for reference only. Yangzhou Yangjie Electronic Technology Co., Ltd. reserves the right to make changes without notice for the specification of the products displayed herein to improve reliability, function or design or otherwise.

The product listed herein is designed to be used with ordinary electronic equipment or devices, and not designed to be used with equipment or devices which require high level of reliability and the malfunction of which would directly endanger human life (such as medical instruments, transportation equipment, aerospace machinery, nuclear-reactor controllers, fuel controllers and other safety devices), Yangjie or anyone on its behalf, assumes no responsibility or liability for any damages resulting from such improper use of sale.

This publication supersedes & replaces all information previously supplied. For additional information, please visit our website [http:// www.frxelec.com](http://www.frxelec.com) , or consult your nearest Yangjie's sales office for further assistance.